

USE PINS FOR AXLES

FRONT VIEW

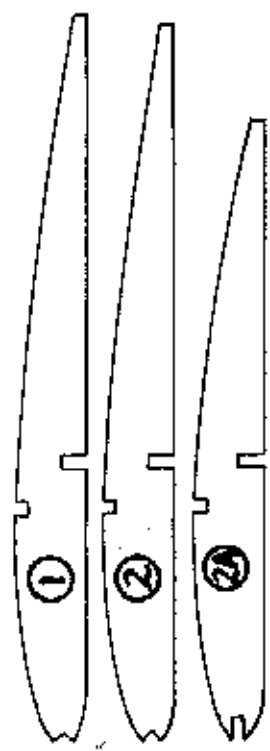

RIBS

SIDE VIEW

(A) (B)

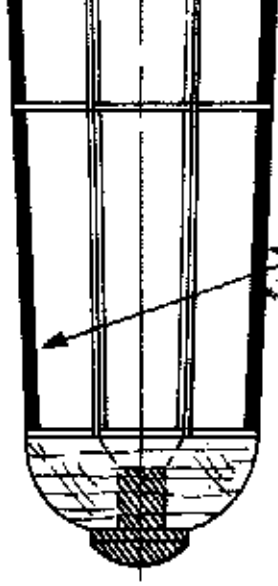

LONGERONS

NOTE: DO NOT
CEMENT NOSE
PLUG IN PLACE

MERCURY JR.

NO. - 86

COPYRIGHT 1939 · PAUL K. GUILLOW

**SIDE
VIEW**

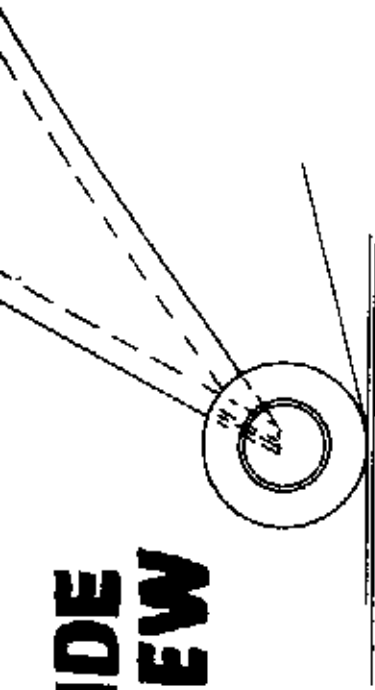

(B)

(C)

(D)

(E)

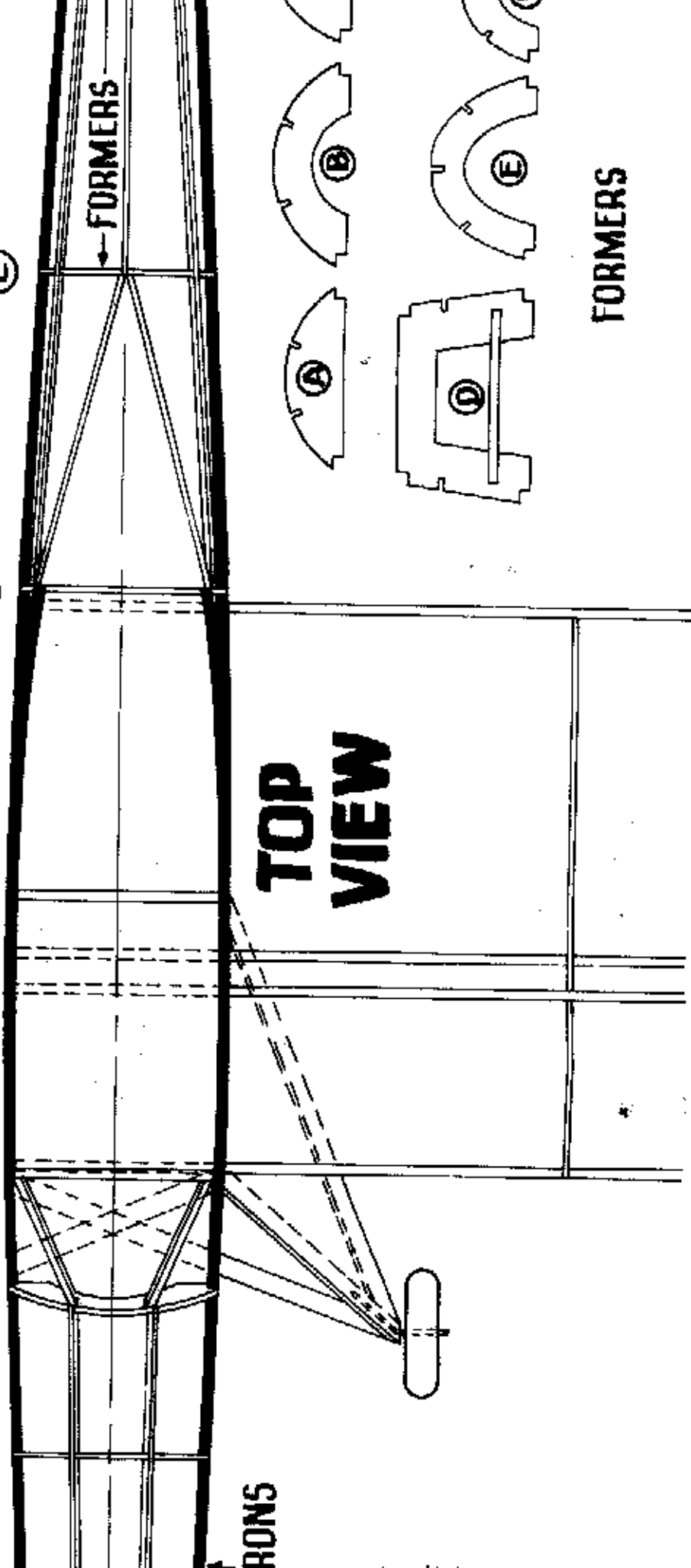

FORMERS

**TOP
VIEW**

FORMERS

FORMERS

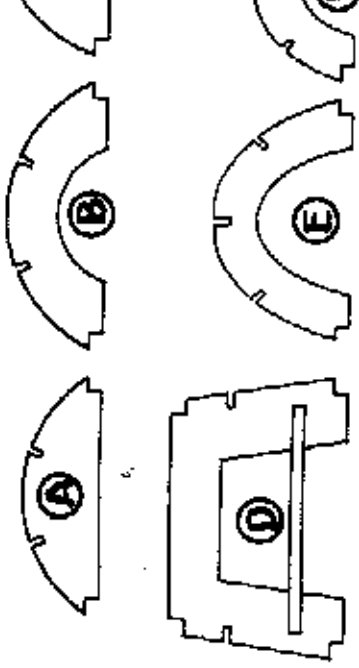

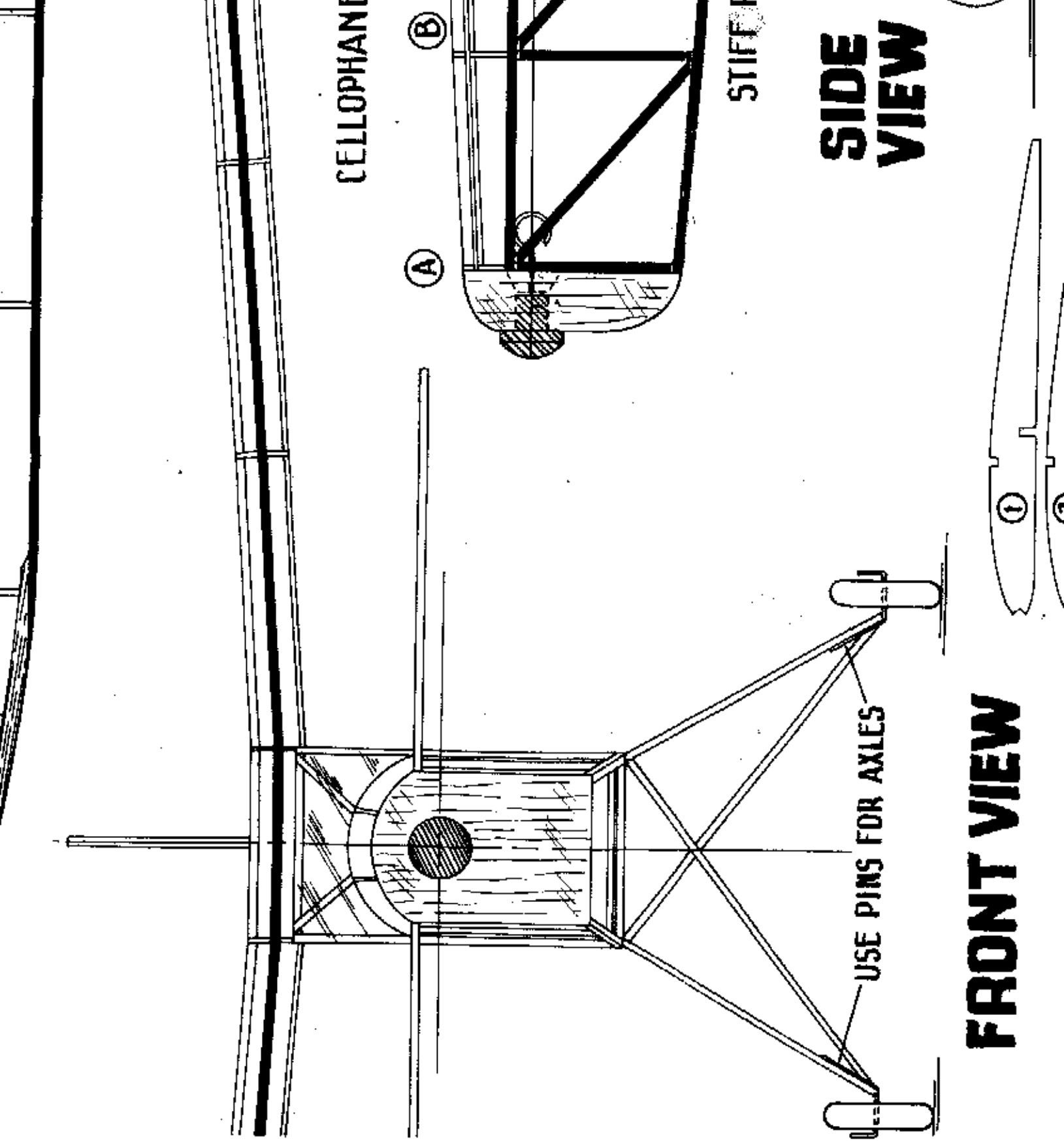

CELOPHAN

A

B

STIFFEN

SIDE VIEW

USE PINS FOR AXLES

FRONT VIEW

1

2

TRAILING EDGE $\frac{1}{16}$ " SQ.

WING LAYOUT

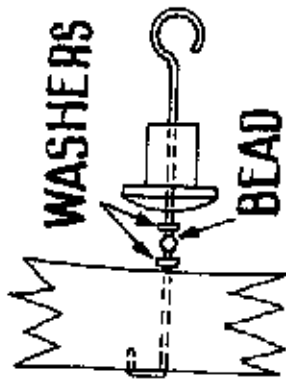

DIHEDRAL 1"

CELLOPHANE

(D)

(C)

(B)

(E)

FORMERS

INTERNAL CROSS STRUTS

LONGERONS

STIFF PAPER

$\frac{1}{16}$ " $\frac{1}{8}$ "

SIDE VIEW



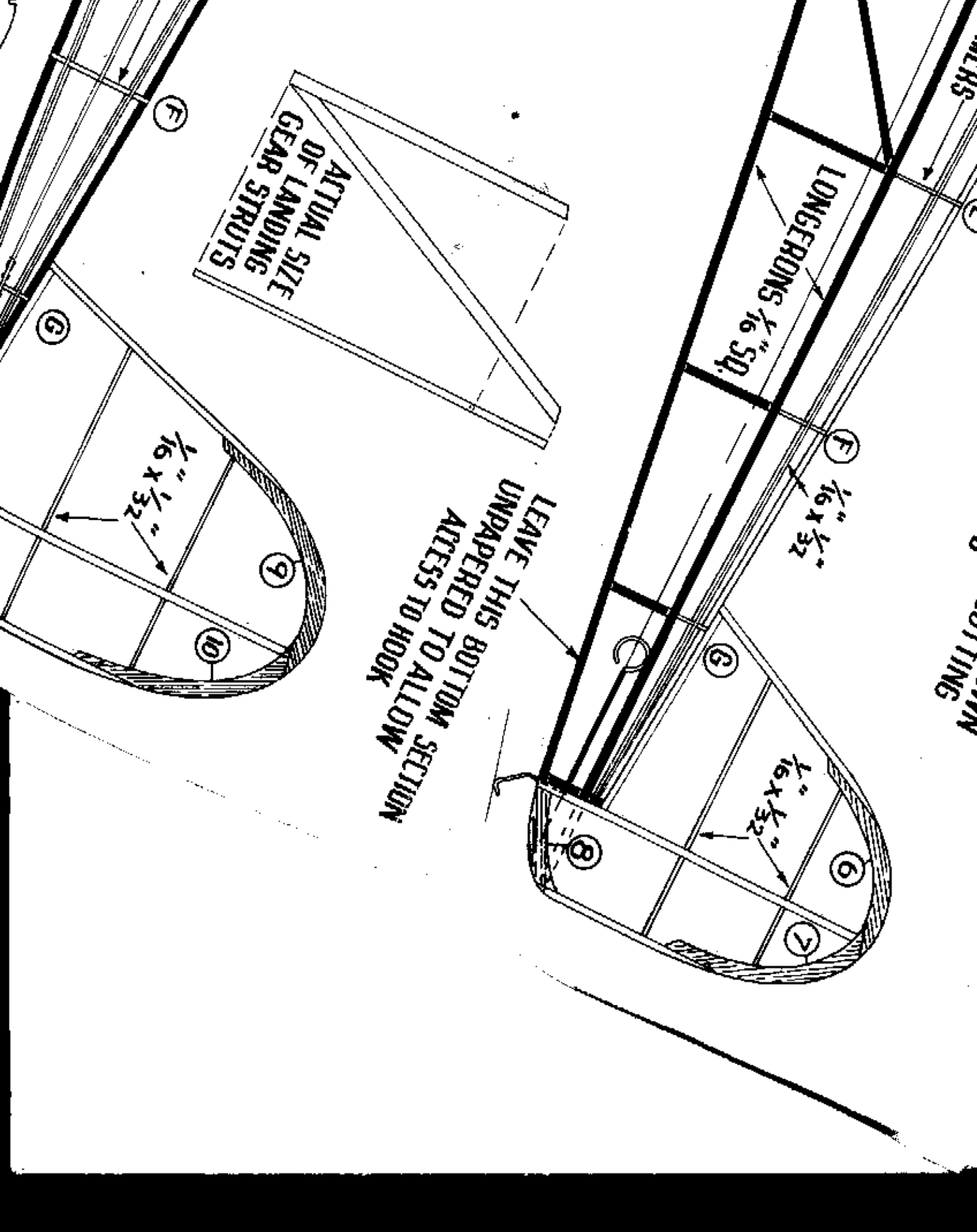

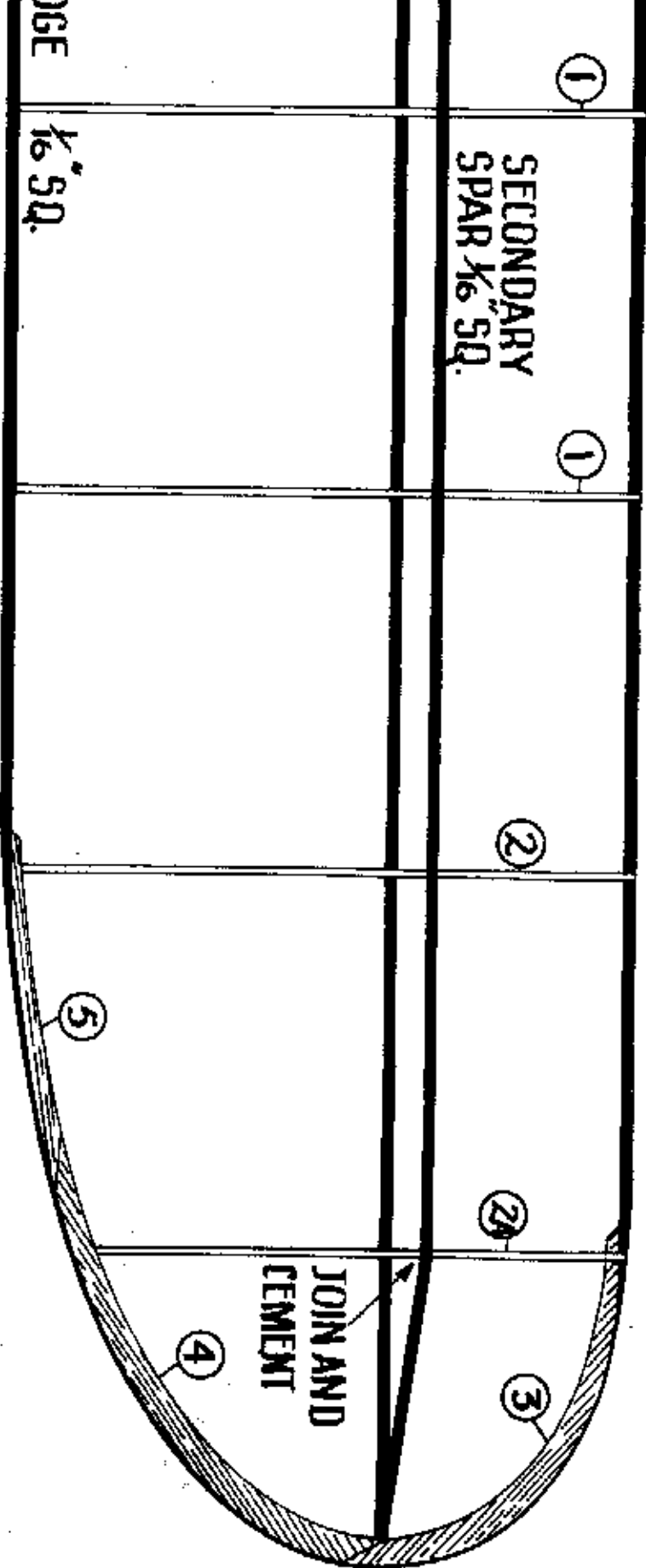

GE
 $\frac{1}{6}$ " SQ.

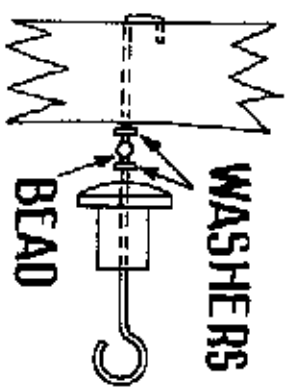

PROP AND SHAFT ASSEMBLY

BREAK RAZOR AS SHOWN
 AND USE FOR CUTTING
 OUT PARTS

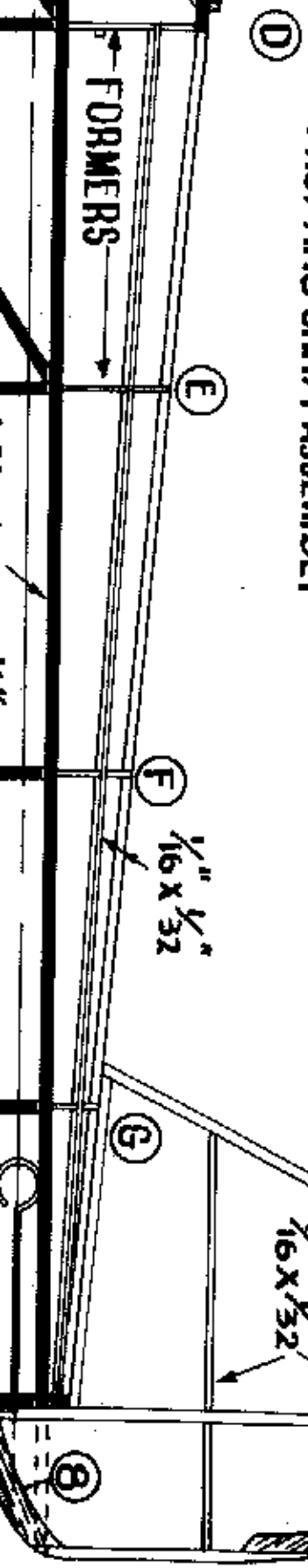
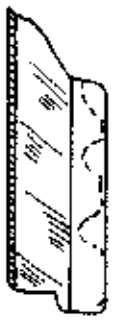

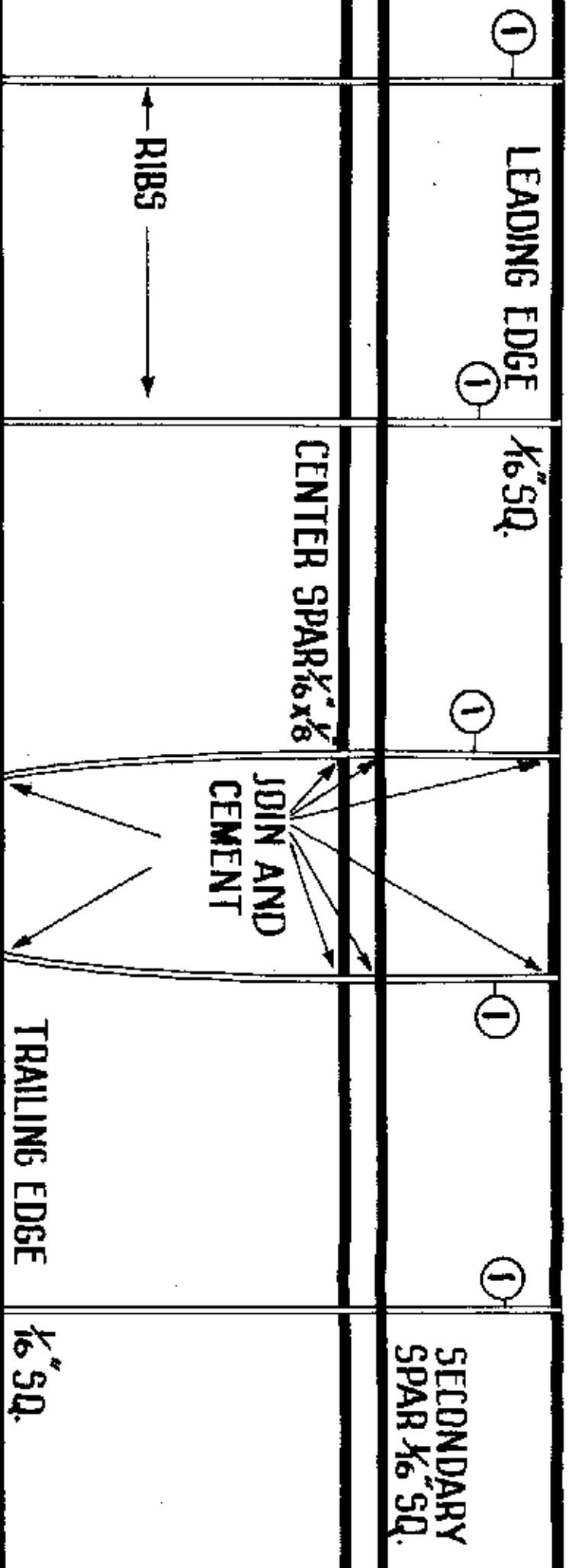

WING LAYOUT

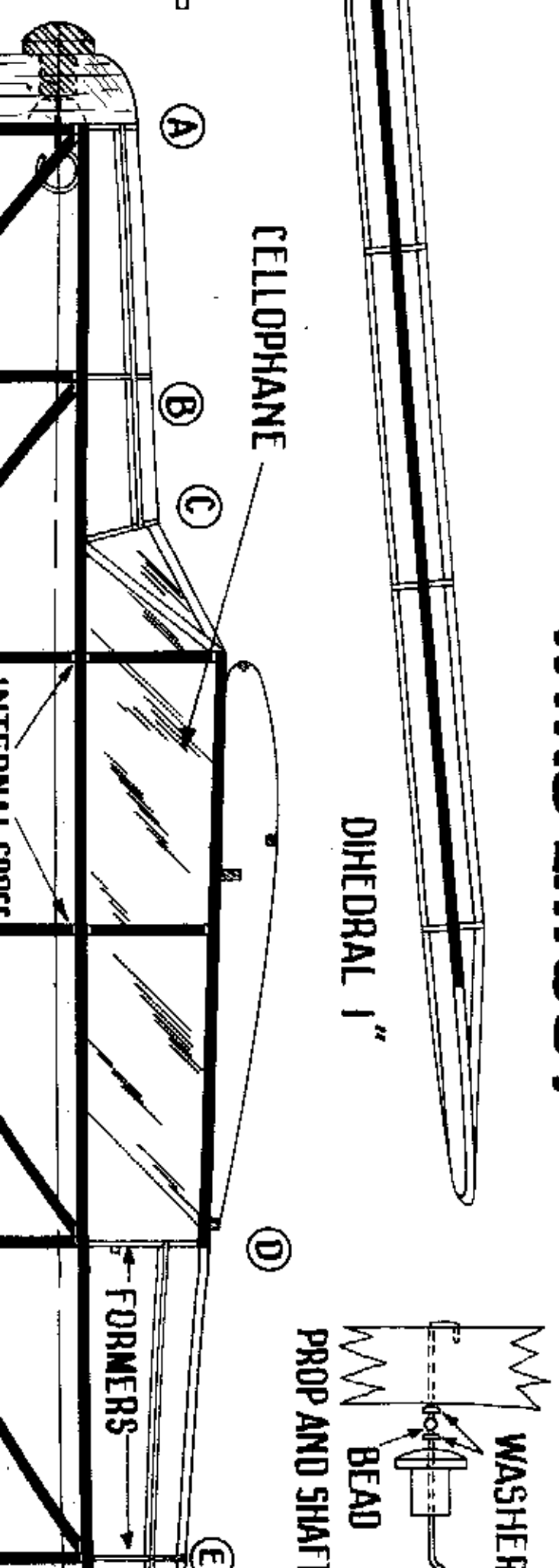

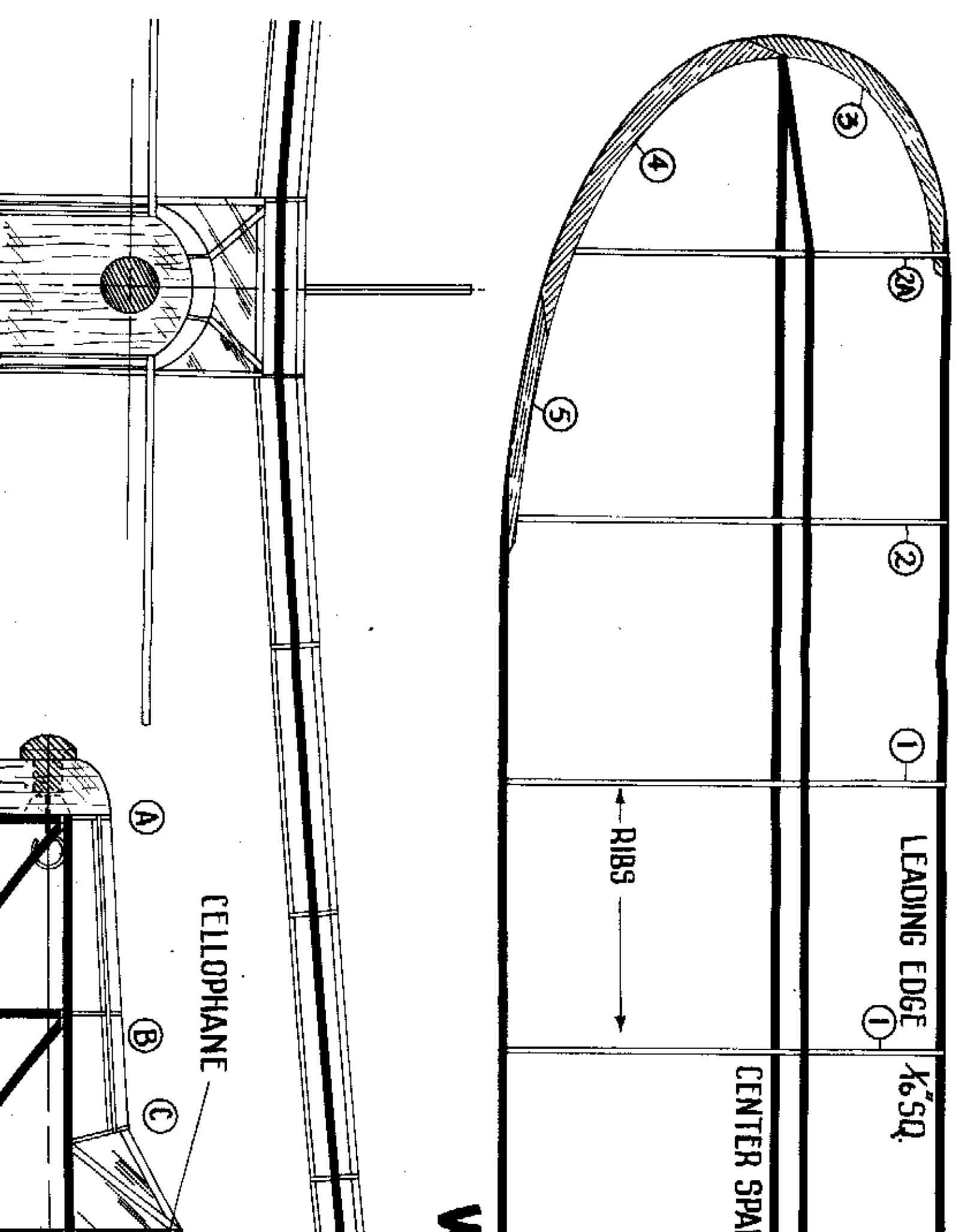

LEADING EDGE

K_0^2 SQ.

CENTER SPACE

RIBS

CELLOPHANE

(A)

(B)

(C)

(2A)

(2)

(1)

(3)

(4)

(5)

V

